

Özellikler

Customs tariff number 84818081

Şalter yolu 0°; 90°

Malzeme Pirinç mahfaza
Steel handle
Pirinç bilye, sert krom kaplı

Bağlantı 1 + 2 NPT iç dış

Conta PTFE bilye contası
O-Ring NBR
O-Ring: FKM (FPM)

Sıcaklık sahası -10 °C to +120 °C
without steam

Sızdırmazlık şekli 1 + 2 dışten contalama

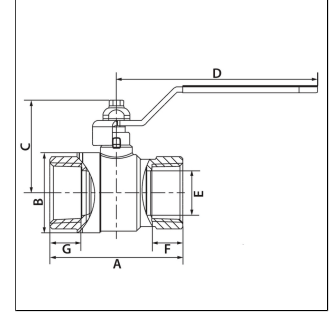

Uyarı

Basınç verileri, -10 °C ile +75 °C arasındaki bir sıcaklık için geçerlidir; daha yüksek sıcaklıklarda basınç kesintileri düşünülmelidir.





Sipariş notu

Başka Basınç ve Sıcaklık Değerlerinde mevcuttur.

Ek bilgiler

Not suitable for steam

Ürün



Adı	DN*	Bağlantı dişlisi	Çalışma basıncı (bar)	C (mm)	A (mm)	F (mm)	B (mm)	E (mm)	D (mm)
BKN 10 ND	10	NPT 3/8" -18	40	41.8	45.4	10.5	24	10	85.5
									
BKN 13 ND	15	NPT 1/2" -14	40	44.3	52.6	14	29	14	85.5
									
BKN 20 ND	20	NPT 3/4" -14	40	55.3	58.6	14.5	36	18.5	113.5
									
BKN 25 ND	25	NPT 1" -11,5	40	60.3	75	17.5	45.5	25	113.5
									
BKN 32 ND	32	NPT 1.1/4" -11,5	40	75.8	82	17.5	57	32	138
									
BKN 40 ND	40	NPT 1.1/2" -11,5	40	78.8	90	17.5	63	37	138

BKN ND

2-way ball valve in low pressure design

HANSA FLEX

Last updated: 31.05.2023

Adı	DN*	Bağlantı dışı	Çalışma basıncı	C	A	F	B	E	D
									
BKN 50 ND	50	NPT 2" -11,5	40	97.8	108	19	84	50	158
									

DN = Nominal çap, nominal genişlik